

CG-T 30" Deep Chrome Plate Series, Thermostatic Griddle



■ 30" Deep Cooking Surface

■ GRIDDLE PLATE SEAM WELD ON TOP & BOTTOM

✓ **WELDED #304 STAINLESS STEEL**
For easy cleaning and long life

✓ **INTEGRATED "FIRE BOX - FLUE"**
Enclosed back, reflects heat up into griddle

✓ **1" Thick CHROMED PLATE**
Consistent Cooking
Temperatures & Faster Heat
Recovery with High-Efficiency
Chrome Surface





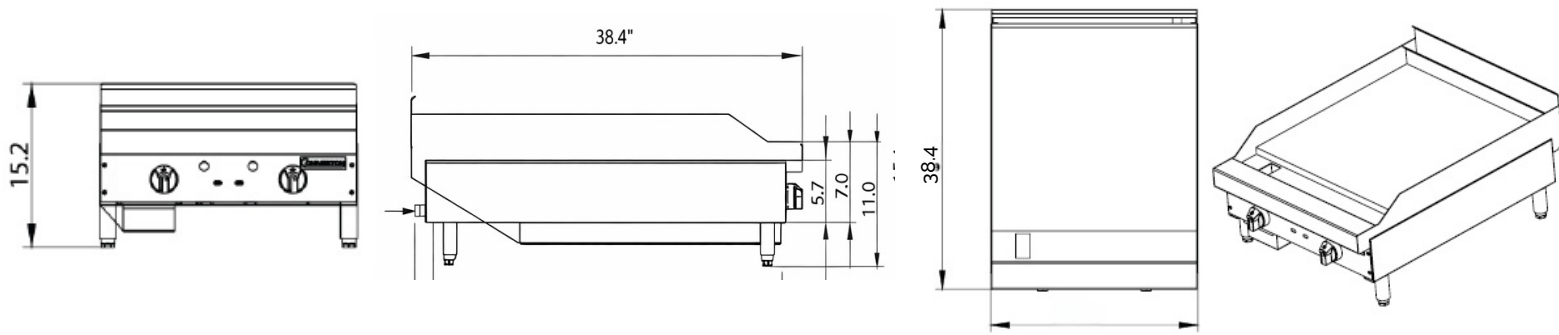







▶ **AVAILABLE OPTIONS:**

- Grooved Griddle Plate
- Floor Model Accessory
- Tall splash - 12" High



MODEL	WIDTH	DEPTH	BTU	BURNERS	WT. (EST)*	WT. (EST)*
CG-24T-CRM	24"	38.4"	60,000	2	205	230
CG-30T-CRM	30"	38.4"	60,000	2	245	270
CG-36T-CRM	36"	38.4"	90,000	3	295	325
CG-42T-CRM	42"	38.4"	90,000	3	335	365
CG-48T-CRM	48"	38.4"	120,000	4	385	420
CG-60T-CRM	60"	38.4"	150,000	5	475	515
CG-72T-CRM	72"	38.4"	180,000	6	565	610

▶ PRODUCT SPECIFICATIONS:

 <p>BODY 16 Gauge #304 Stainless Steel, Fully Welded</p>	 <p>FIRE BOX 16 Gauge #304 Stainless Steel, Welded to Body</p>	 <p>FRONT Removable 18 Gauge #304 Stainless Steel Panel</p>	 <p>PLATE 1" Highly polished steel plate</p>	 <p>GUTTER 14 Gauge #304 Stainless Steel</p>	 <p>SPLASH 14 Gauge #304 Stainless Steel, 3" High</p>
 <p>BURNERS 30,000 BTU, U-type Tubluer burner,</p>	 <p>DRIP PAN 18 Gauge #304 Stainless Steel</p>	 <p>VALVES Heavy Duty Brass</p>	 <p>GAS INLET ¾ NPT</p>	 <p>GAS PRESSURE 5.0" Natural, 10" Propane (Inches Water Column)</p>	 <p>LEGS (FLOOR MODEL) #304 Stainless Steel tubing with Stainless Steel undershelf and adjustable feet or castors</p>

▶ NOTES:

Gas Pressure Regulator is supplied and must be installed Combustible Locations: 8" Clearance sides and back Non-Combustible Locations Only:

- 0" Clearance sides and back
- Specify counter or floor model
- Specify type of gas and altitude if over 2,000 feet



Connerton reserves the right, without notice, to make changes and revisions in product specifications, materials and design, which in our opinion will provide better performance, durability and efficiency.